

NOVA LUCE

9186973

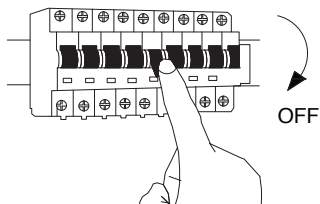

1. Turn off the general switch

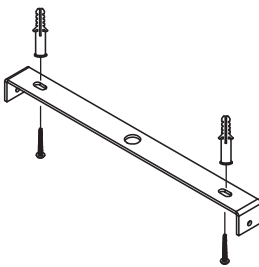

2. Align drill holes apply plastic anchors
With screws

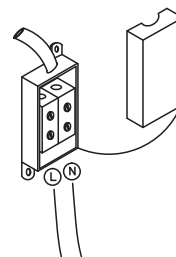

3. Connect the wires

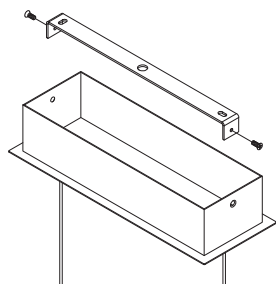

4. Apply the side screws

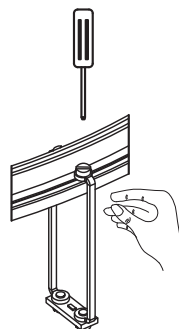

5. Fix it in place

When the frames or LEDs are not straight, please loosen one screw and straighten them by hand, then tighten the screw.

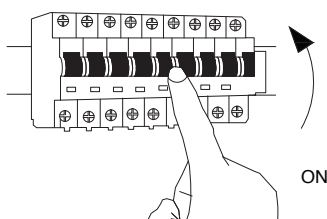

6. Turn on general switch

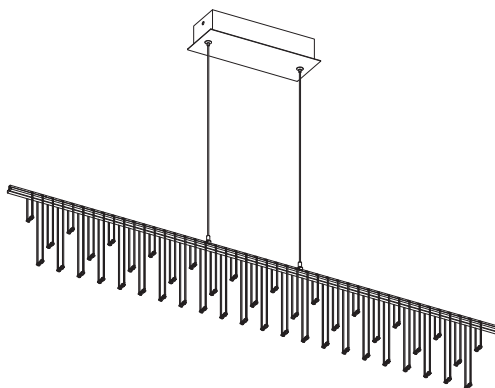

- a) This light fitting operates at a normal supply voltage of 220-240V.
- b) If the external flexible cable or cord of this luminaire is damaged. It shall be exclusively replaced by the manufacturer or his serviceagent or a similar qualified person in order to avoid a hazard.