

# NOVA LUCE

9345702, 9345703, 9345706

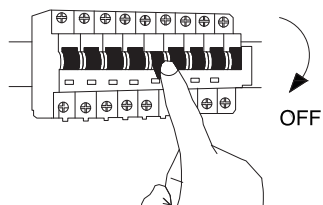

1. Turn off the general switch

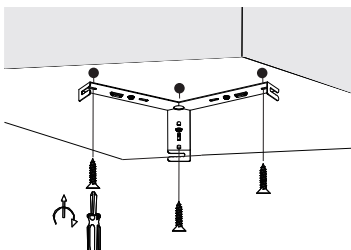

2. Mark where to drill holes

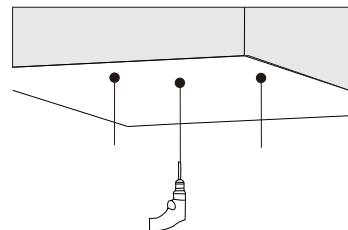

3. Drill on the marked areas

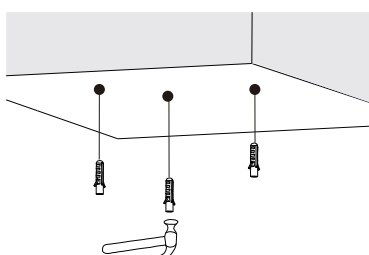

4. Apply plastic anchors

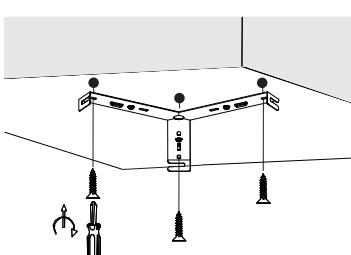

5. Apply screws

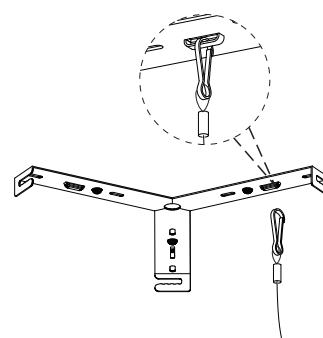

6. Make it stable

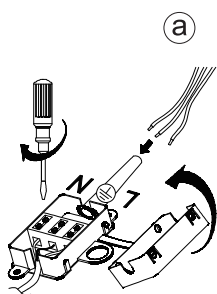

7. Connect the wires

**b** **CCT SWITCH**  
Color temperature switch

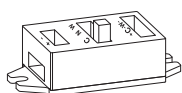

Warning:  
Please not to change  
color when power on.

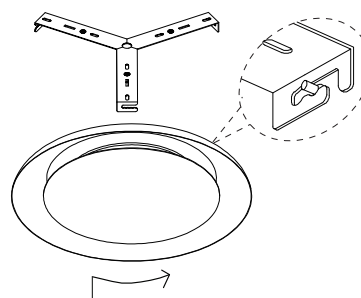

8. Apply the product by rotating

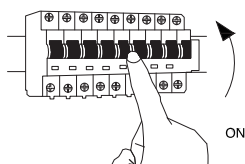

9. Turn on the general switch

