



Installation

VK/03087/PE

SINCE 1978



LEADING LIGHT

ATTENTION: For this operation you have to cut off the power!

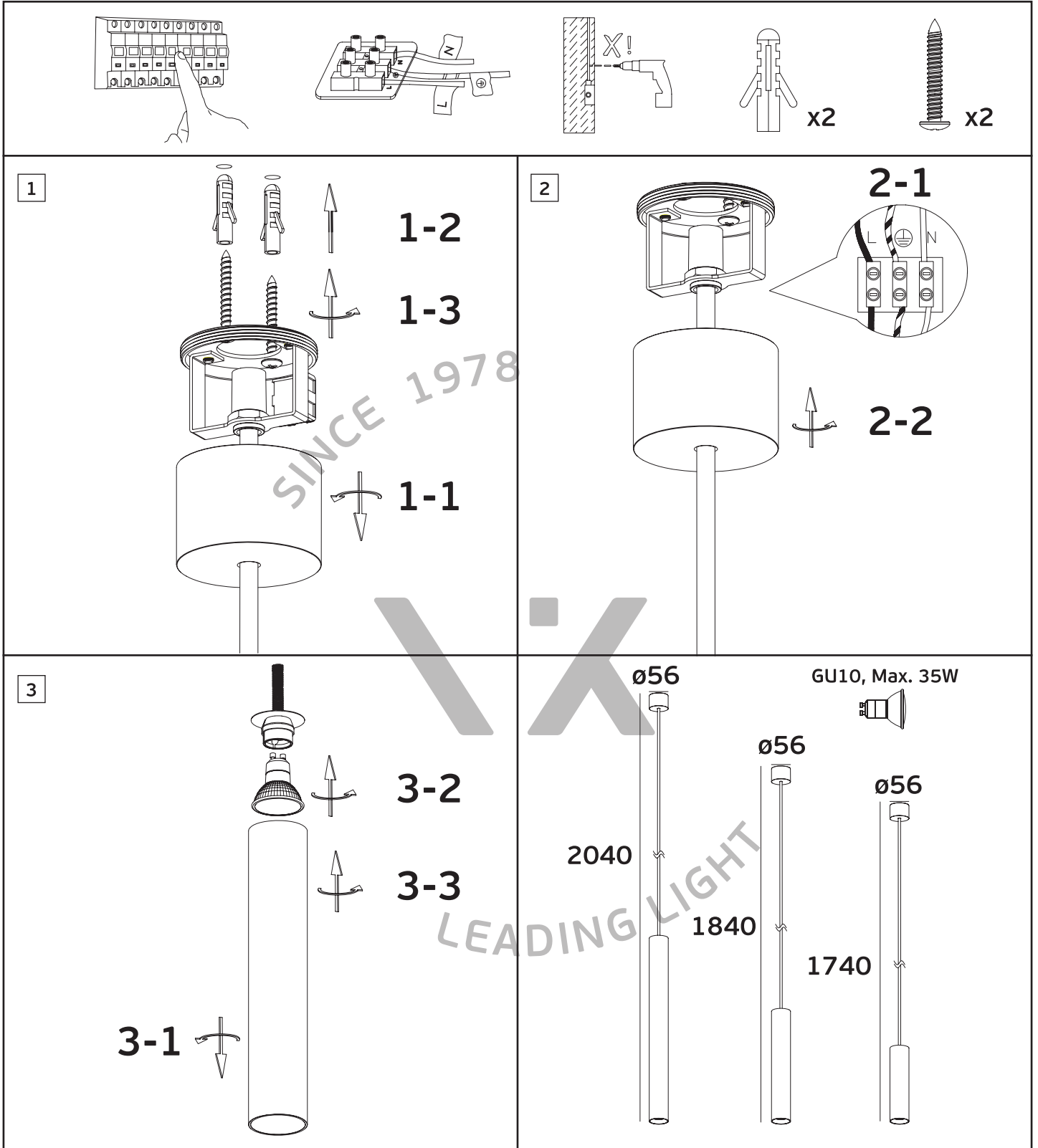

VK Leading Light / Vaios I. Karakostas S.A. Imports - Exports Trade

A: 8 Aristotelous St, Tavros, 177 78 Athens, Greece T: +30 210 99 69 610-11, +30 210 34 58 072, +30 210 34 58 075
F: +30 210 99 58 374 E: info@vkleadinglight.gr W: vkleadinglight.gr